

# Installation instructions for 24.2724 / 24.2725

## Under Run Protective Shield Engine Bay and Transmission Case

### LEXUS NX300h



### RAV 4 Hybrid



Model Year: LEXUS NX300h 2014 -

RAV 4 Hybrid (аналог Nx340h)  
2.5L Hybrid 2WD E-CVT  
2.5L Hybrid E-AWD E-CVT  
2016 -

Vehicle Code: AYZ15L-AWXLBW

AVA42L-ANXMBX  
AVA44L-ANXMBX  
AVA42L-ANXGBX  
AVA44L-ANXGBX



Part Number:

Steel: 24.2724  
Aluminium: 24.2725

Weight:

Steel: 9,17 kg  
Aluminium: 5,75 kg



Installation Time:

30 min

**A**

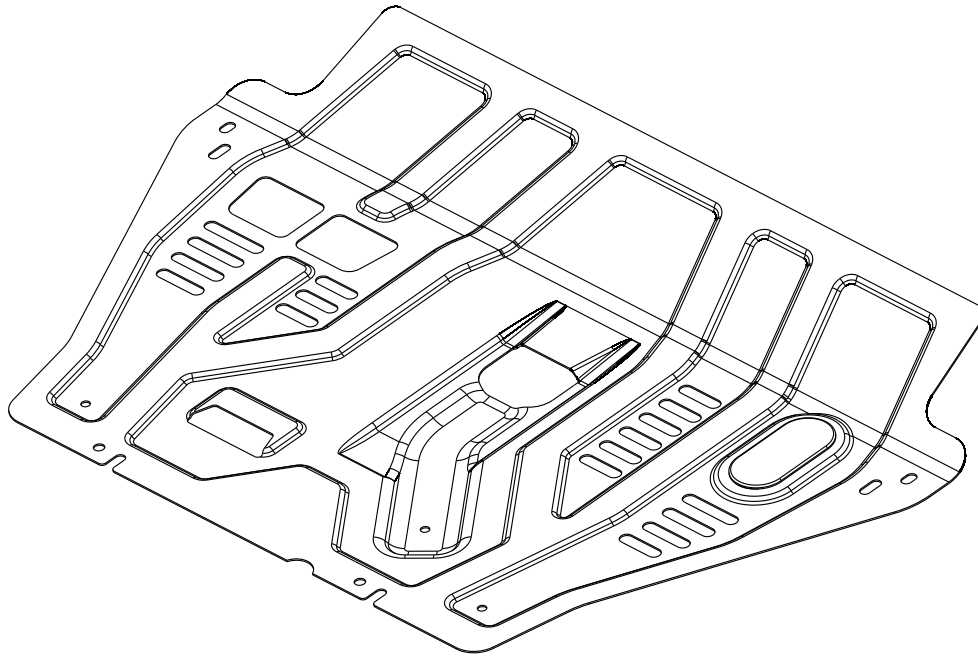

**B1**



M10x20

2x

**B2**

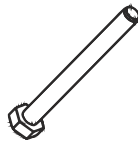

M10x100

2x

**C1**



Ø 10

4x

**C2**

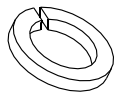

Ø 10G

4x

**D**

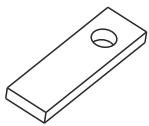

2x

**E**



2x

**F**

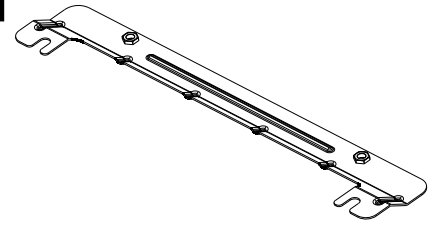

1x

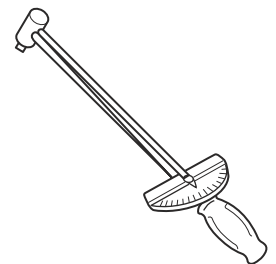
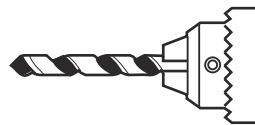
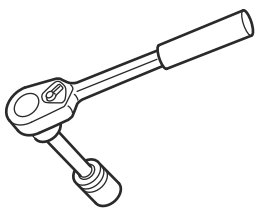

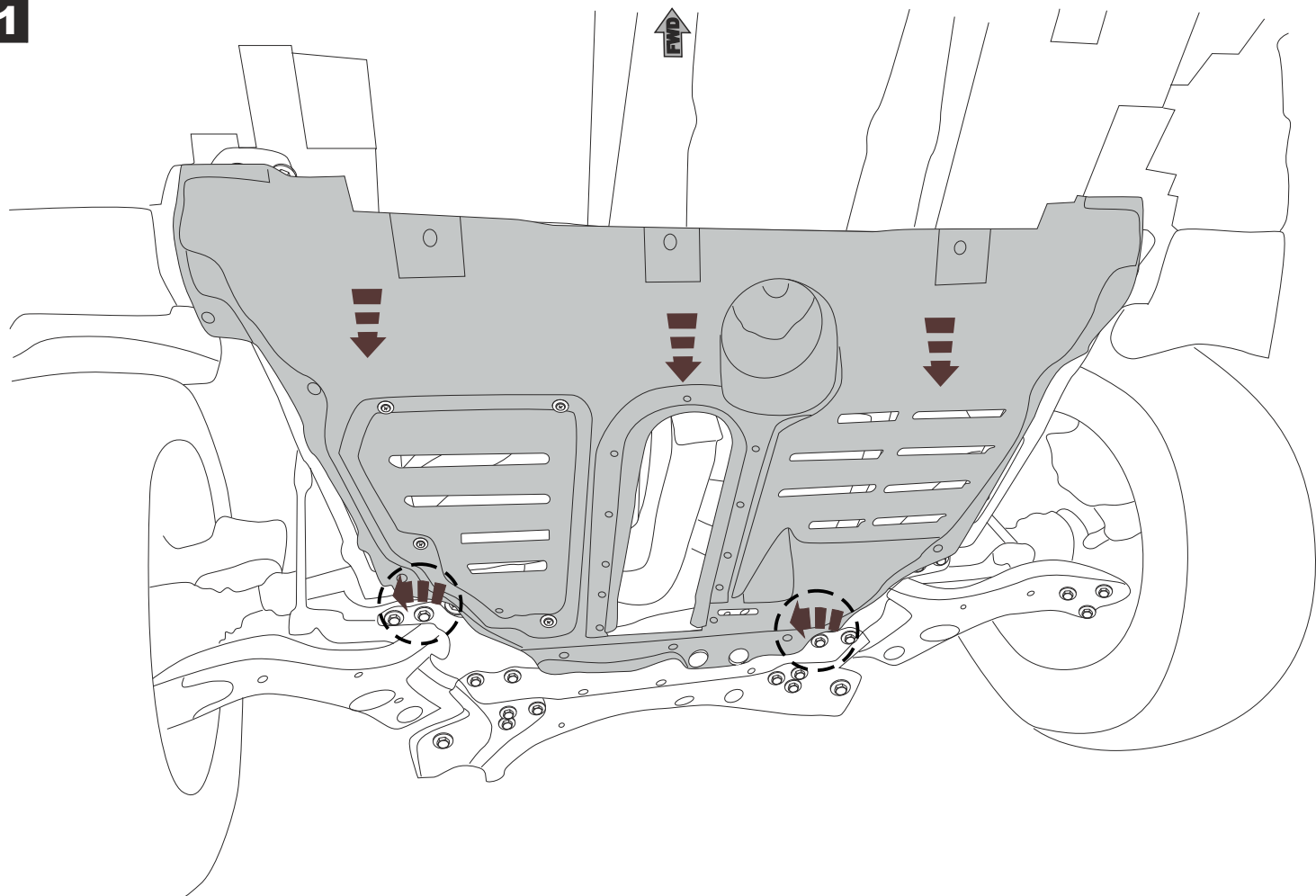
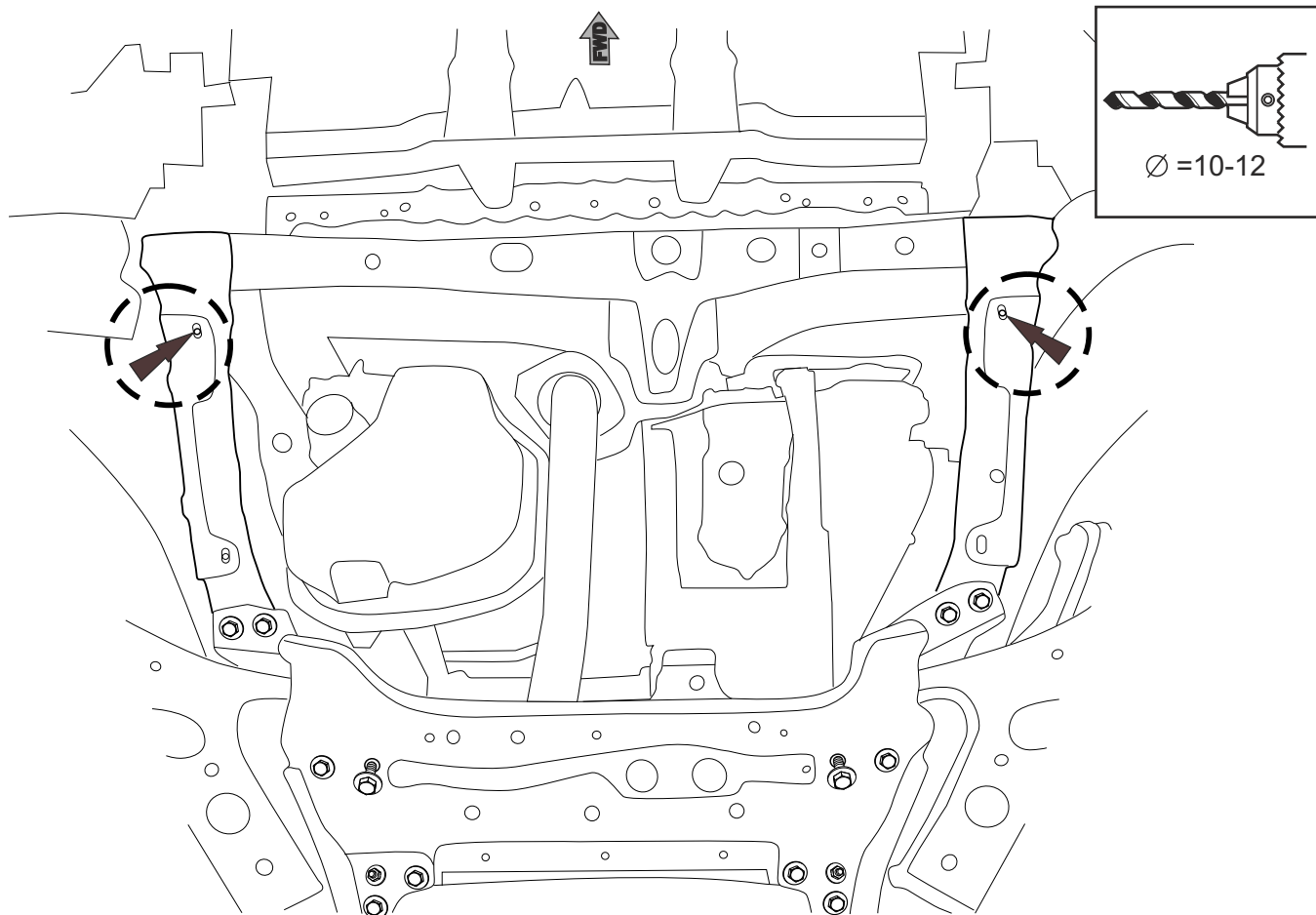
**1****2**

3

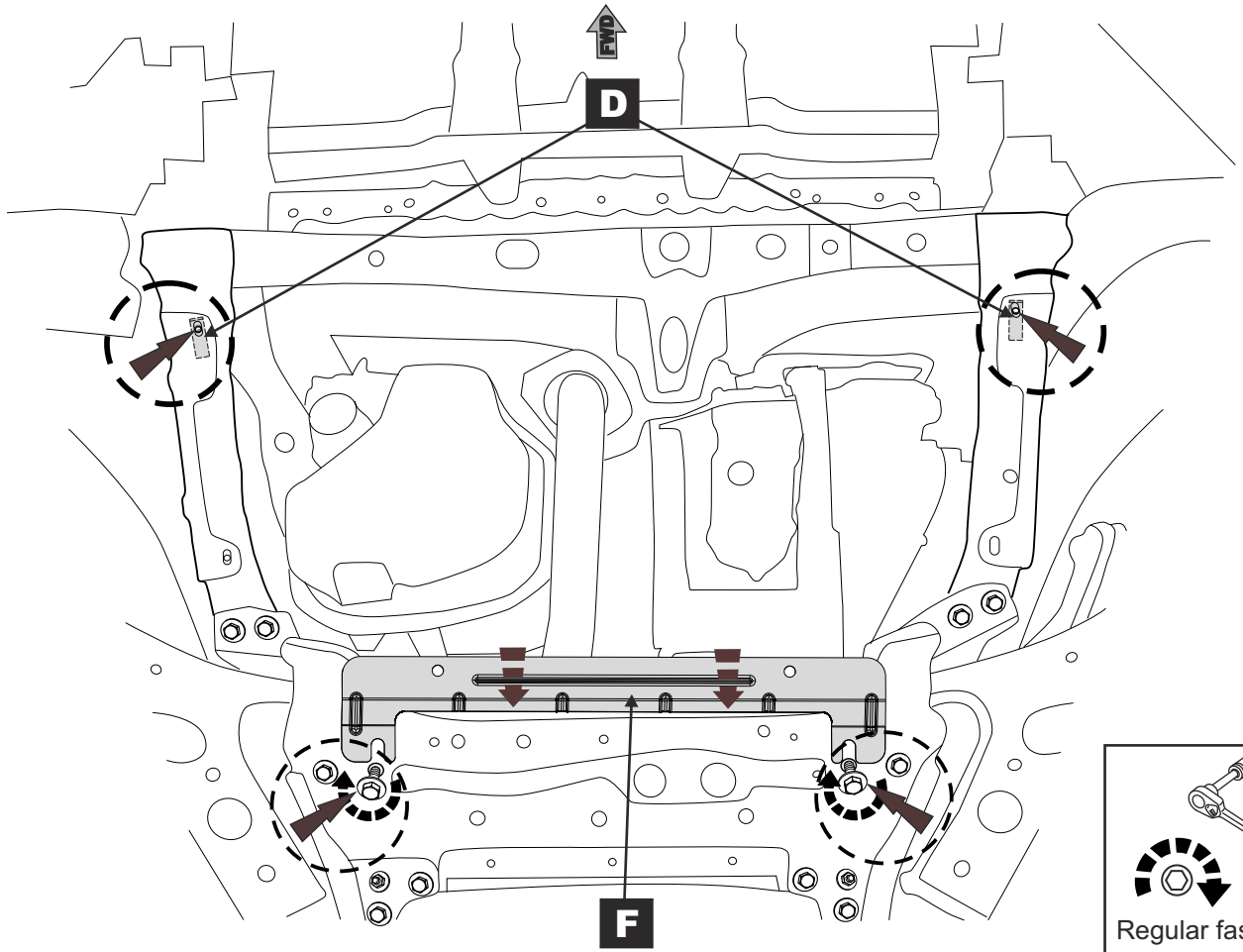

4

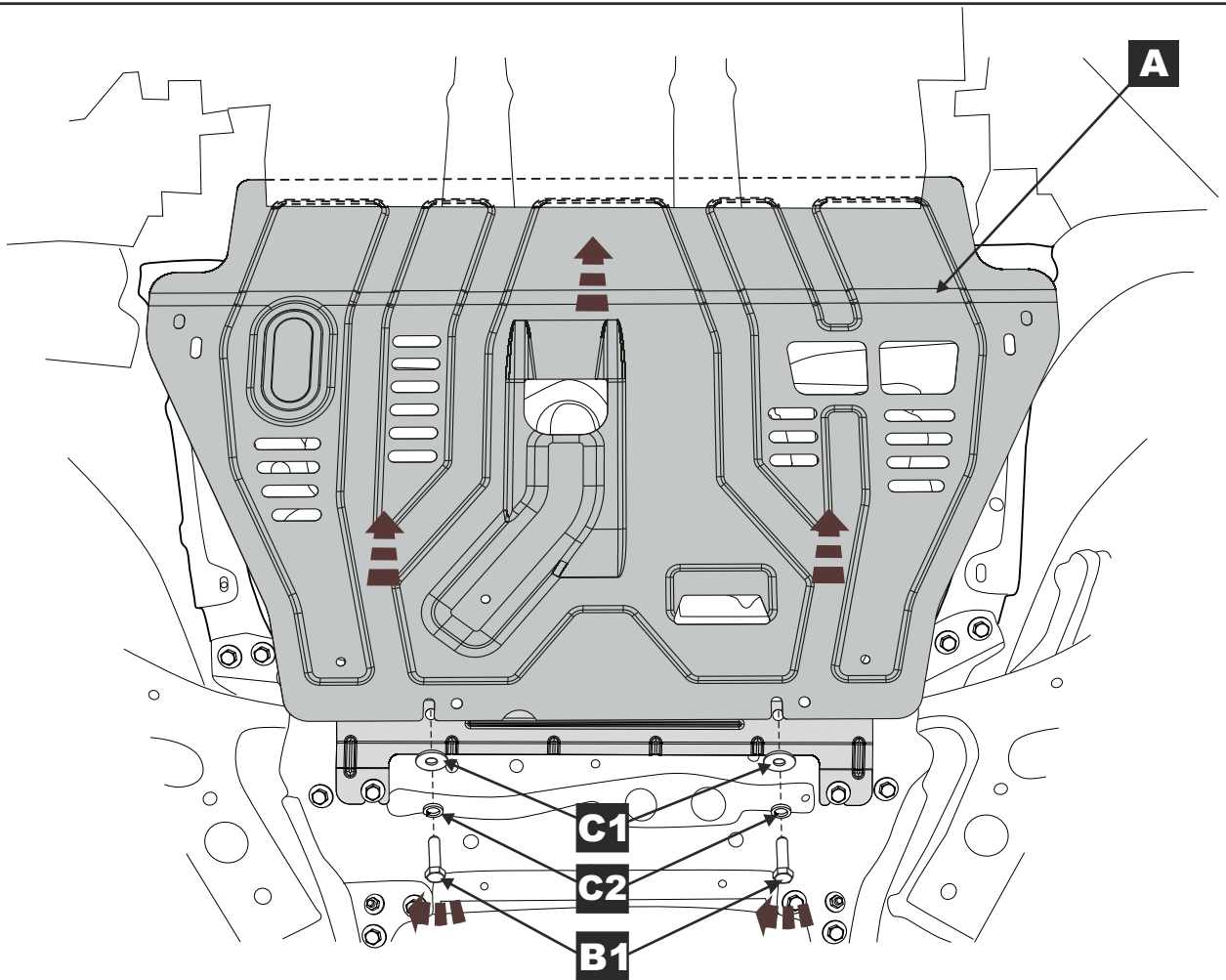

**5**

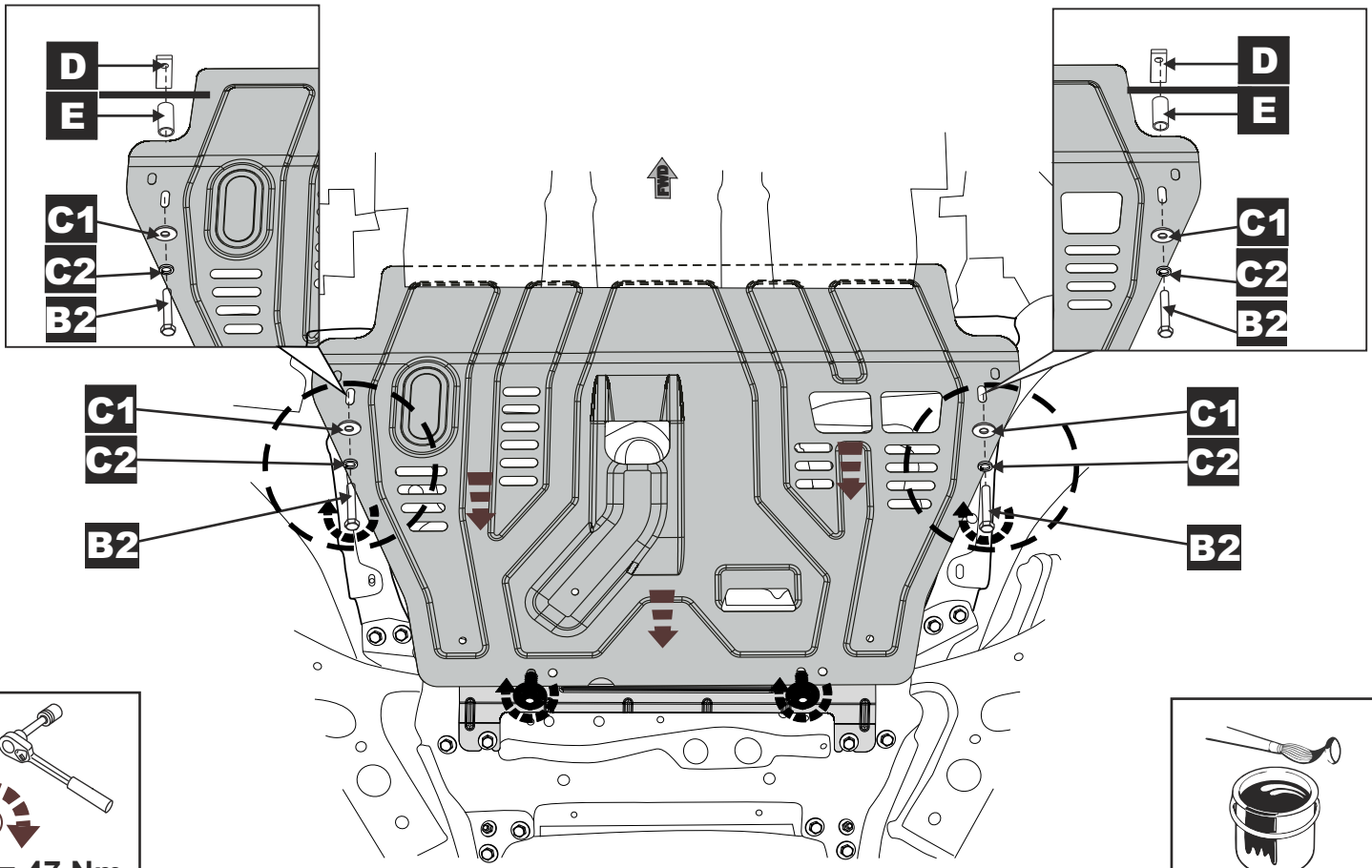

**6**

