



Installation instructions for PZ4AL-01597-00, PZ4AL-01588-00 Under Run Protective Shield fuel tank

LEXUS LX 570

Toyota Land Cruiser 200



Model Year	LX 570 - 2010; LX 570 MC - 2011	LC200 - 2007	LC200MC - 2012
Vehicle Code	URJ201L-GNTGKW	UZJ200L-GNAEKW VDJ200L-GNTEZW	URJ202L-GNTEKW VDJ200L-GNTEZW
Part Number		Steel: PZ4AL- 01597- 00 Aluminium: PZ4AL- 01588- 00	
 Weight			Steel: 17,37 Kg Aluminium: 10,26 Kg
 Installation Time			50min

A

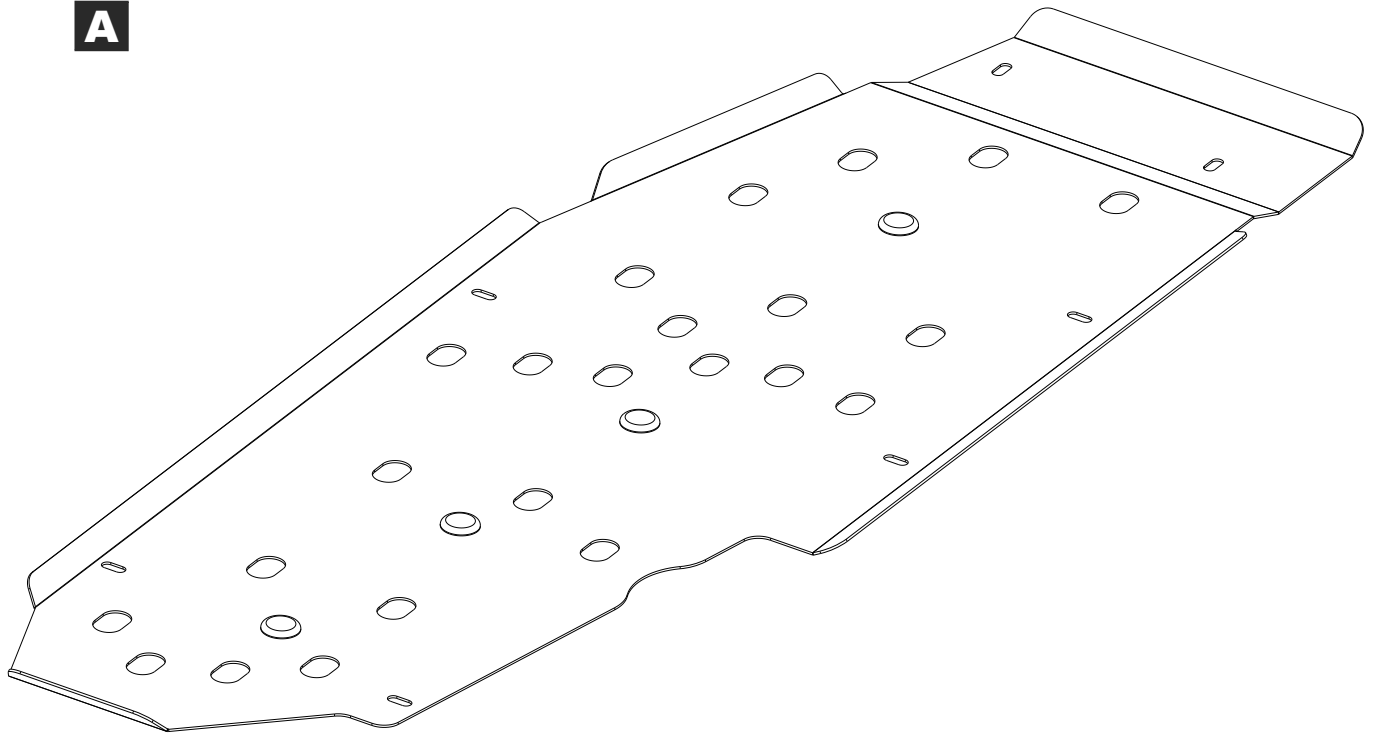

PZ4AL-01597-60

B1

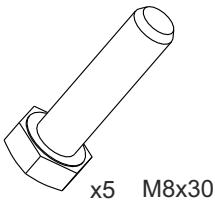

B2

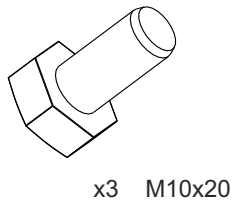

B3

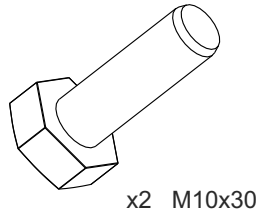

C1

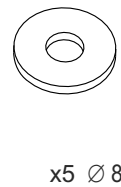

C2

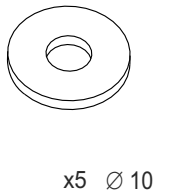

D

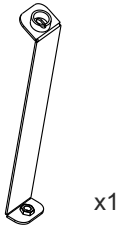

E



F

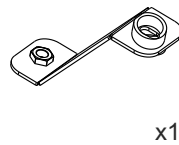

G

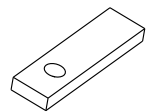

H

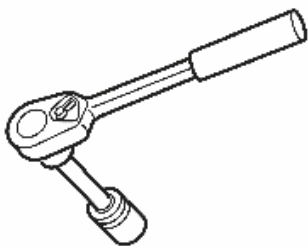
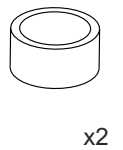

1

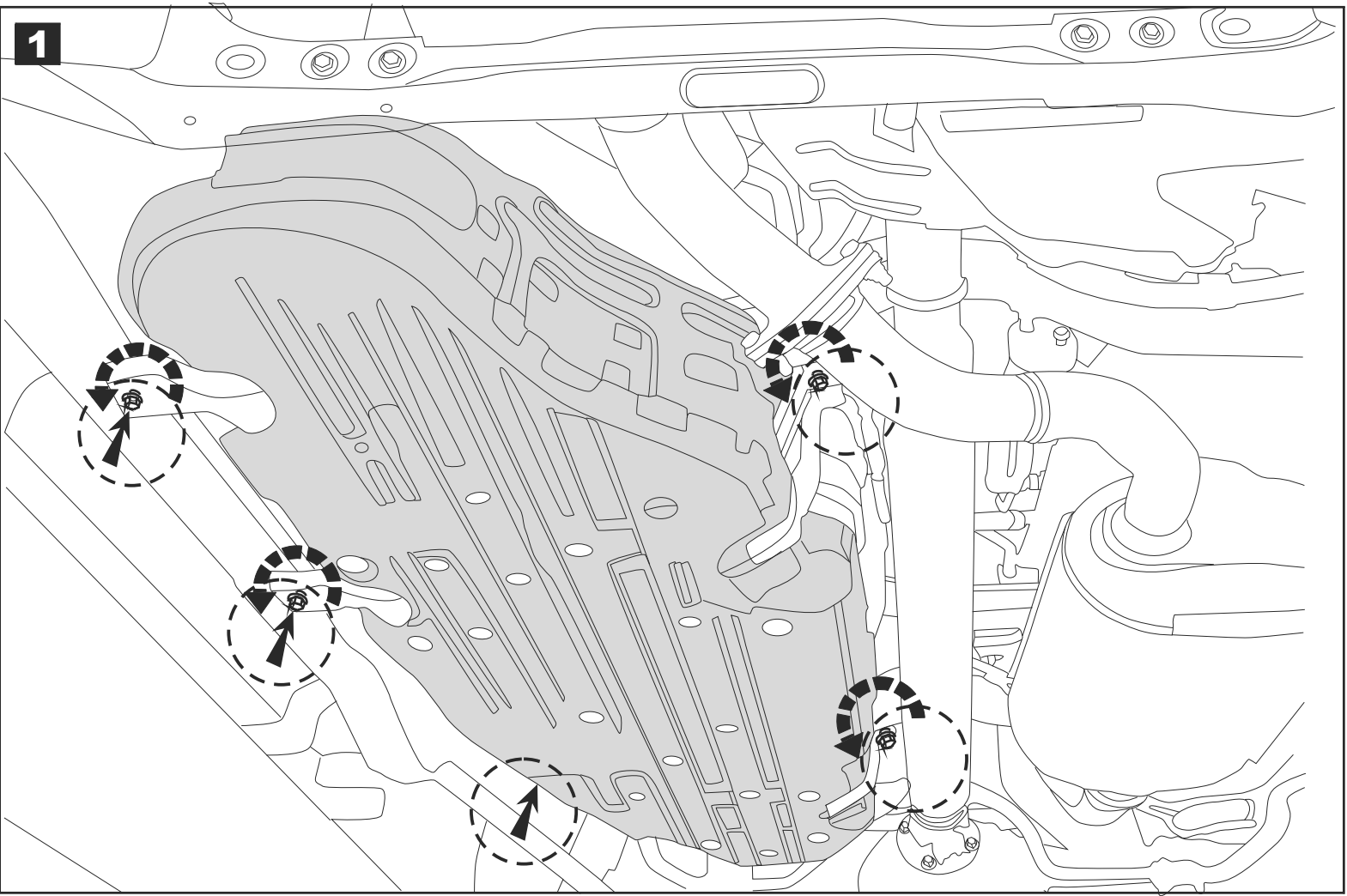

2

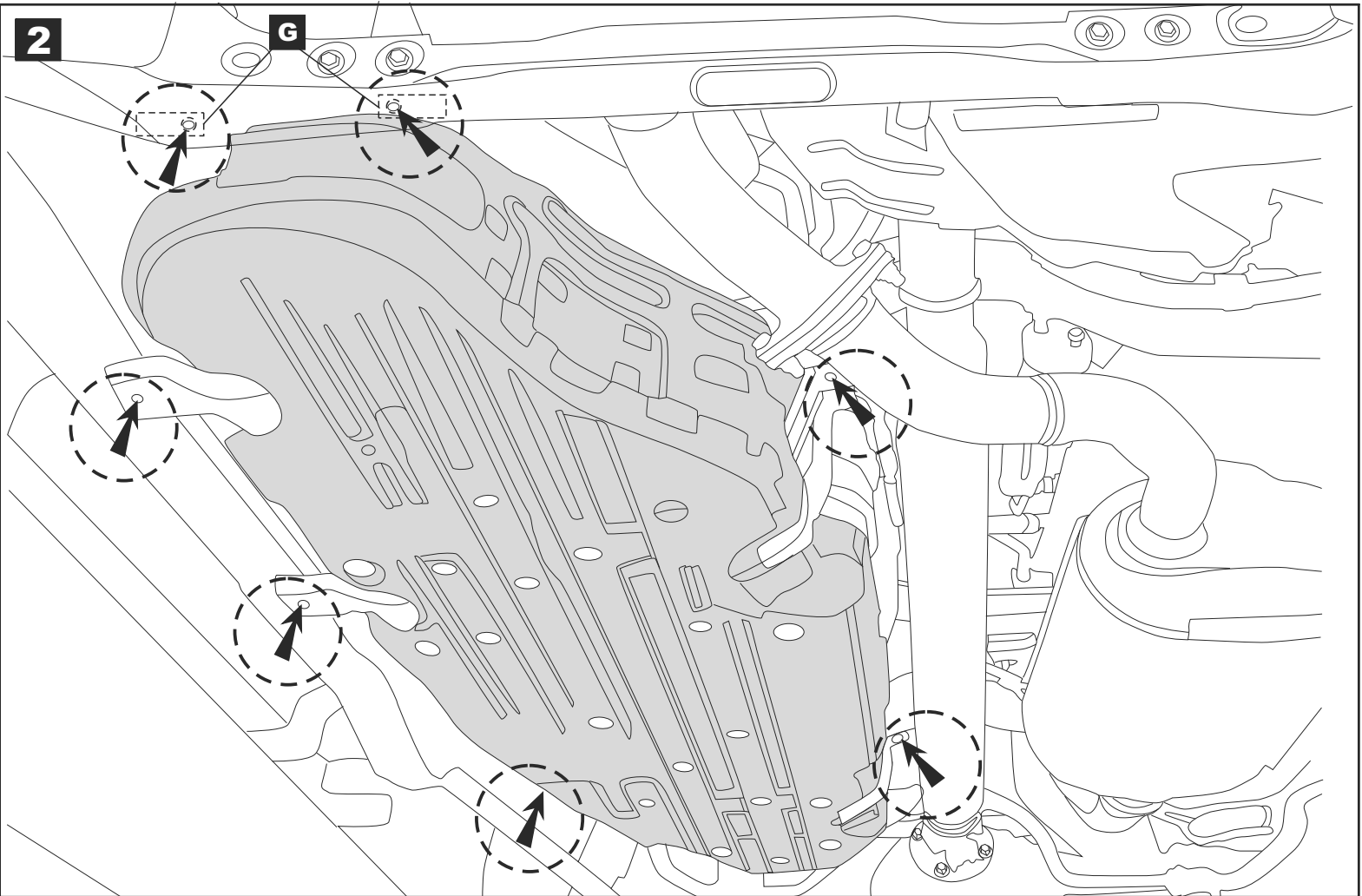

3

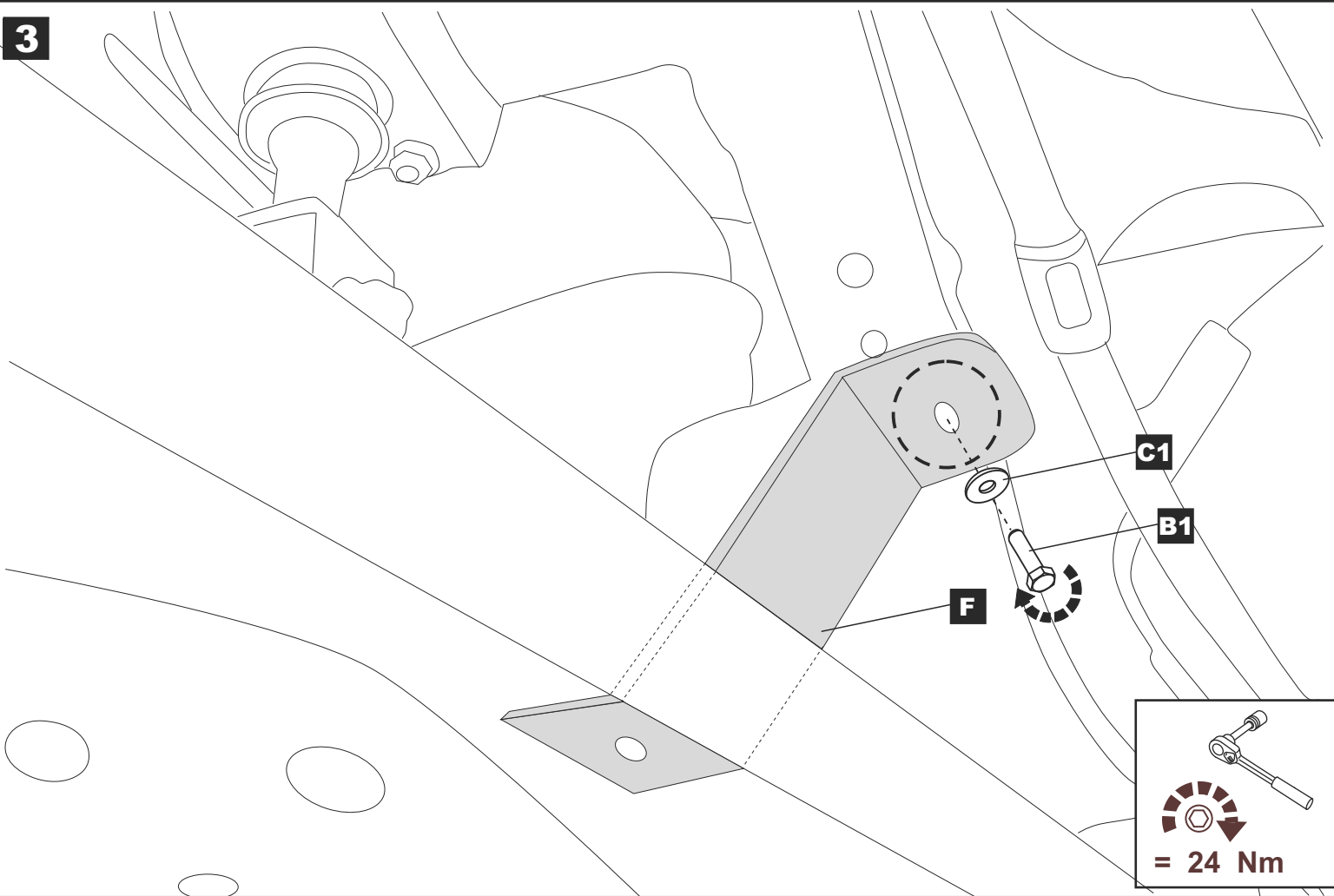

4

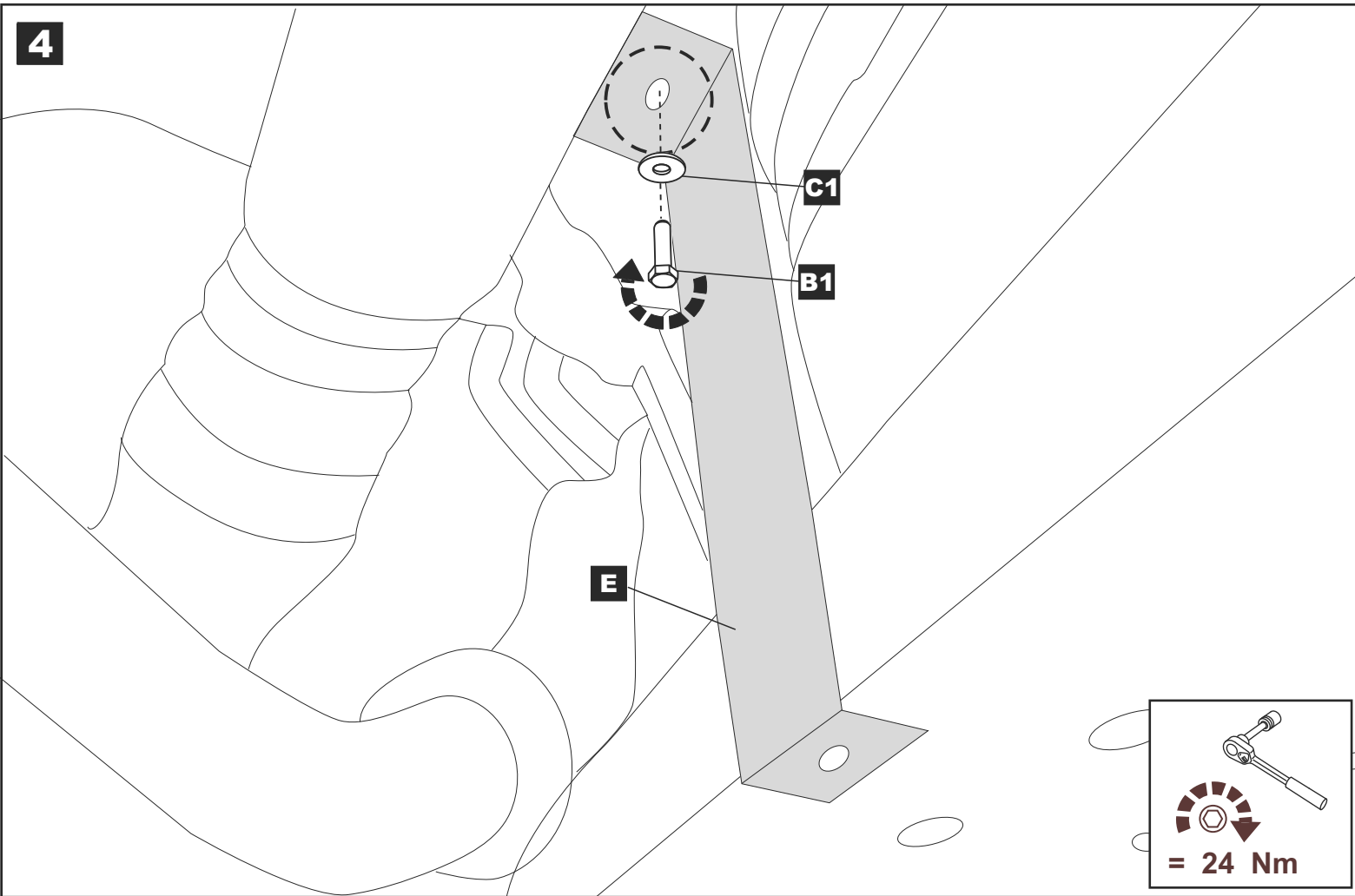

5

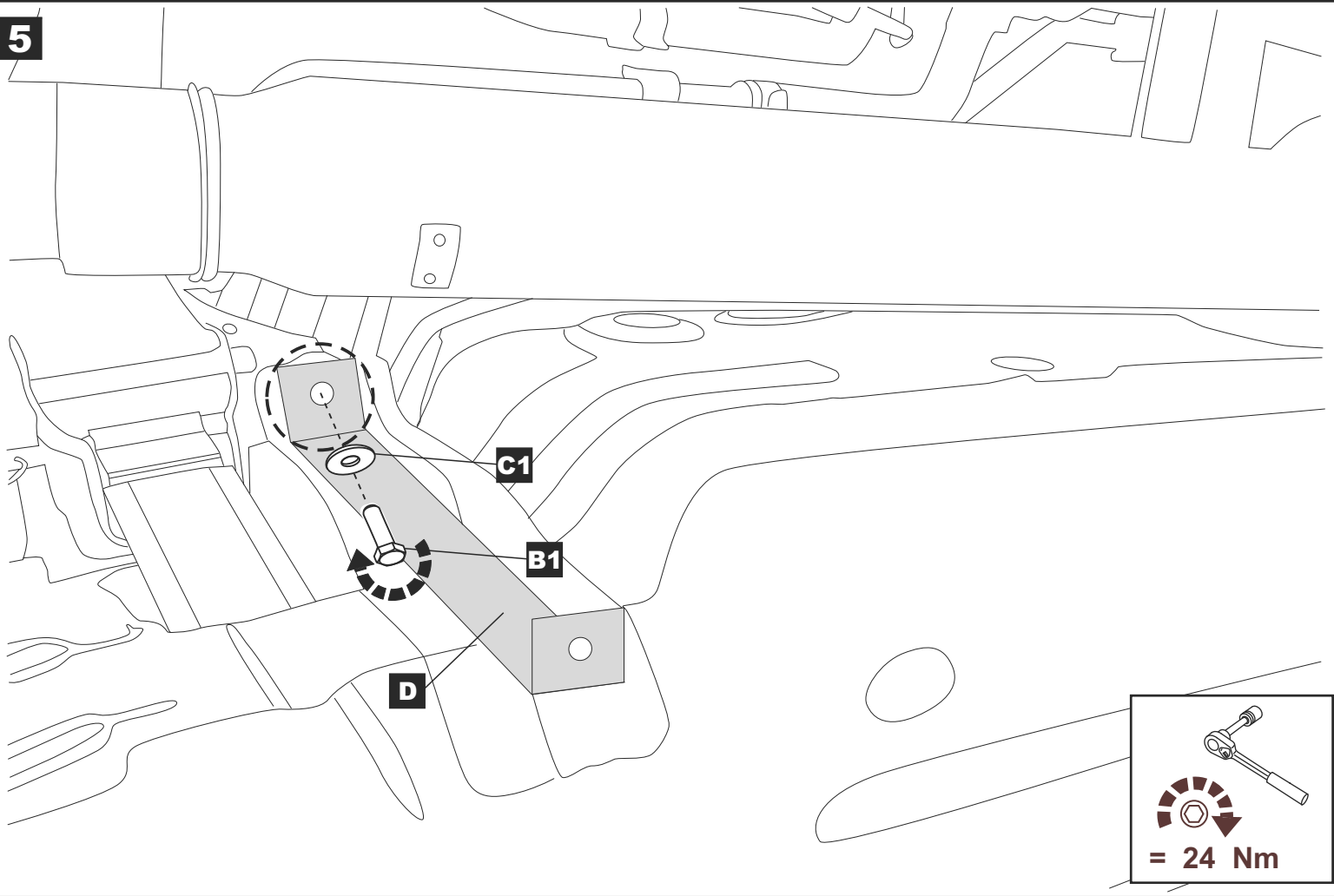

6

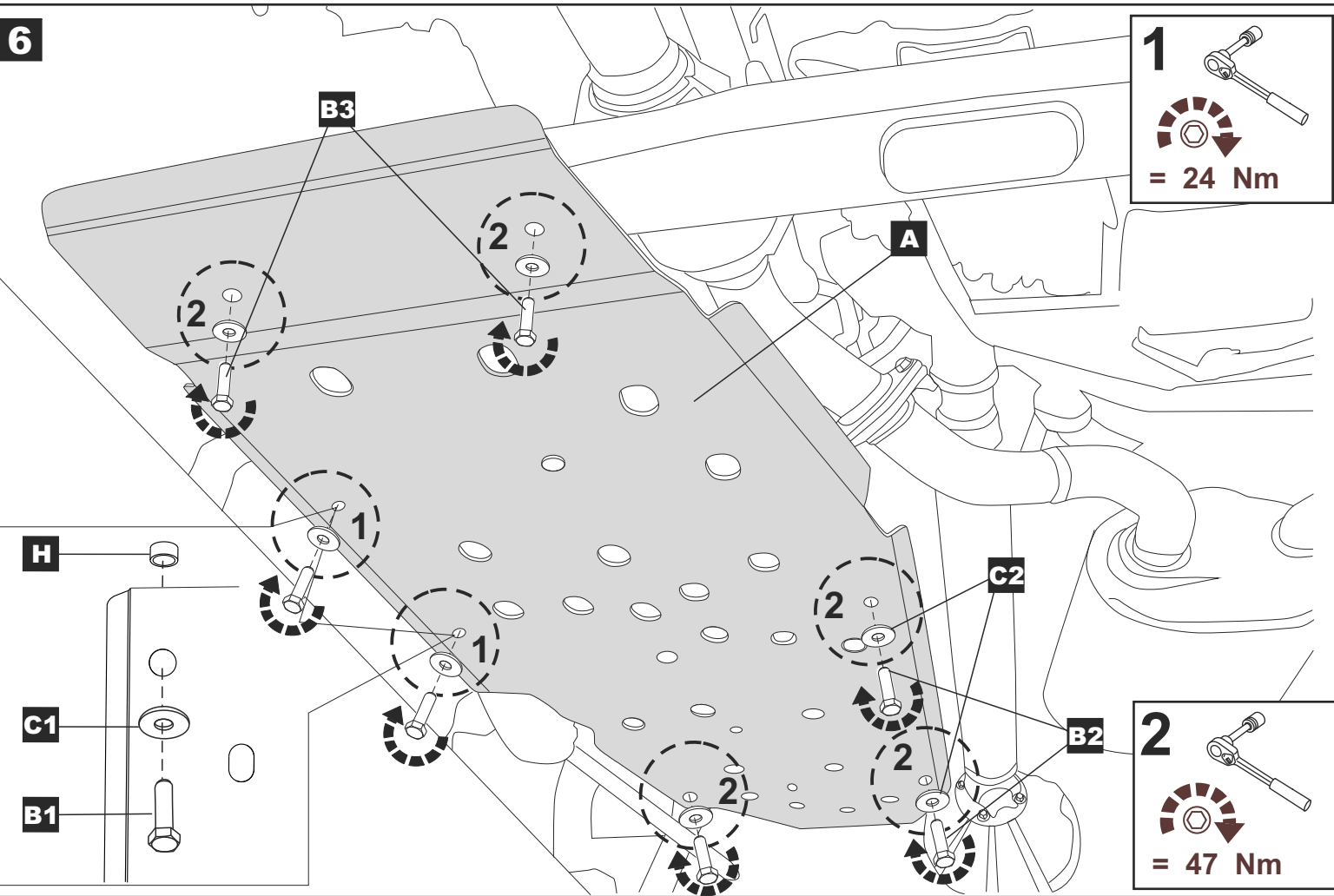

7

