



CITROEN Jumpy 1,6D (90 H.P) MT FWD
TOYOTA Proace 2,0D (177 H.P) AT FWD

2018 -

05.4415/05.4416
24.4415/24.4416

25/11/19

1/6



(GB) Location/Position Arrow

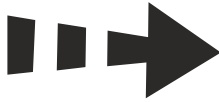

(GB) Movement Arrow



(GB) Screw Arrow

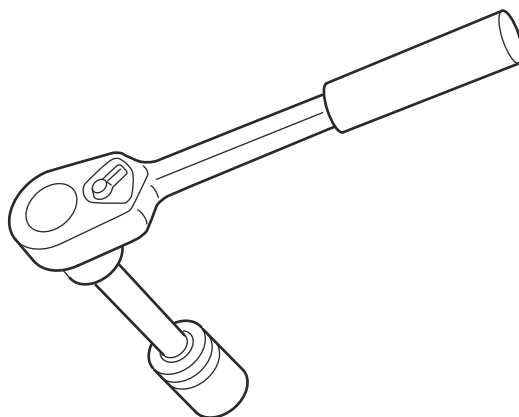
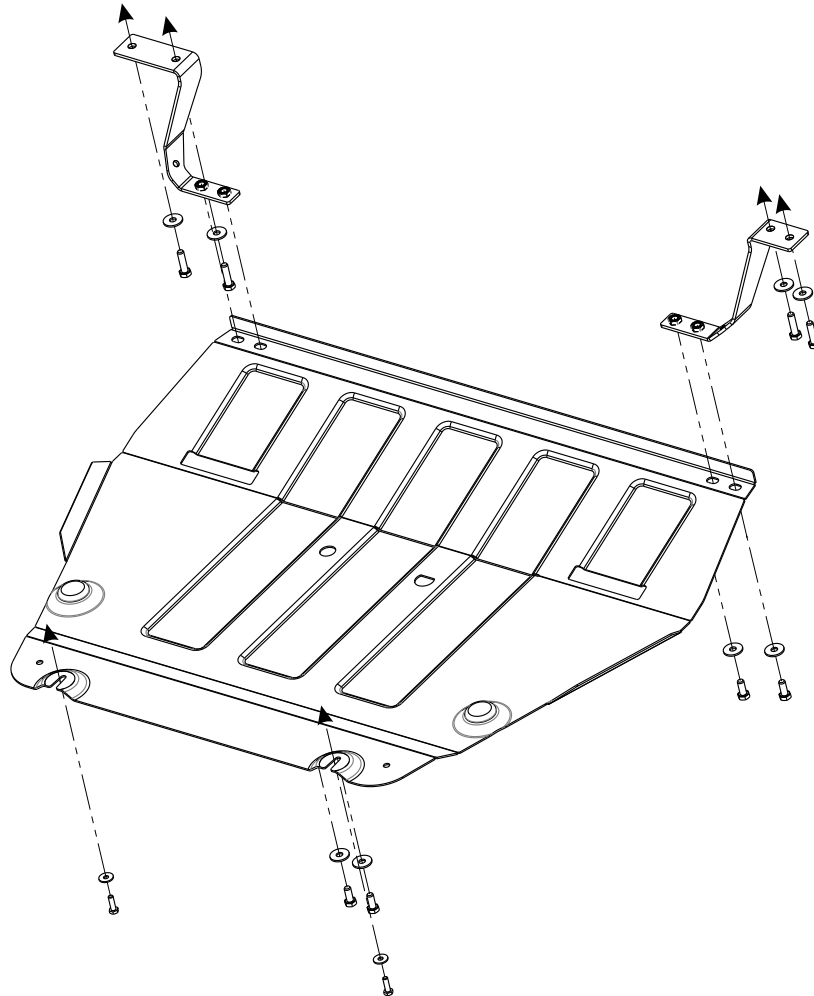

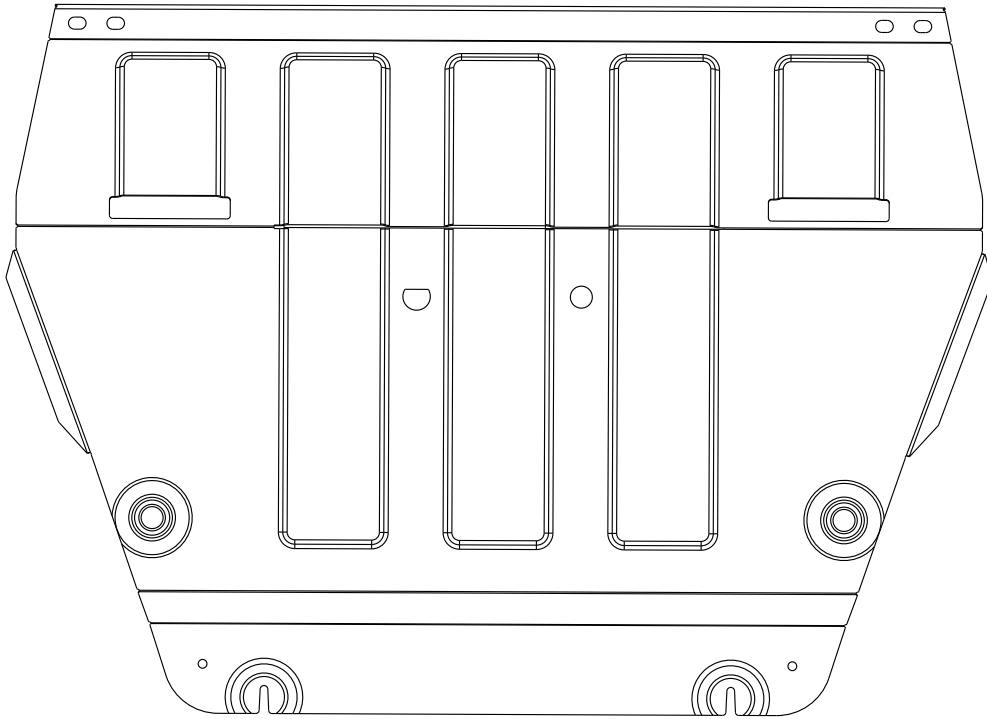
A

1X

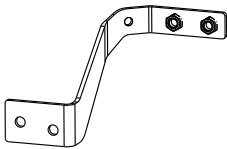
B

1X

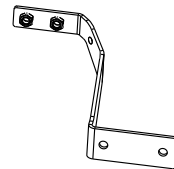
C

1X

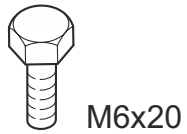
D

M6x20

2X

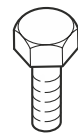
E

M8x20

4X

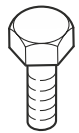
F

M8x30

4X

G

Ø6

2X

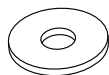
H

Ø8

8X



05.4415/05.4416
24.4415/24.4416

25/11/19

3/6

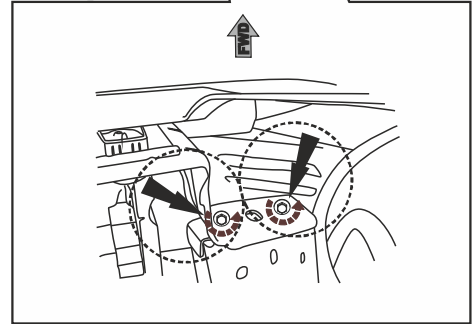
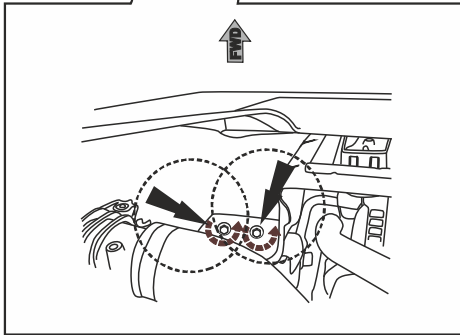
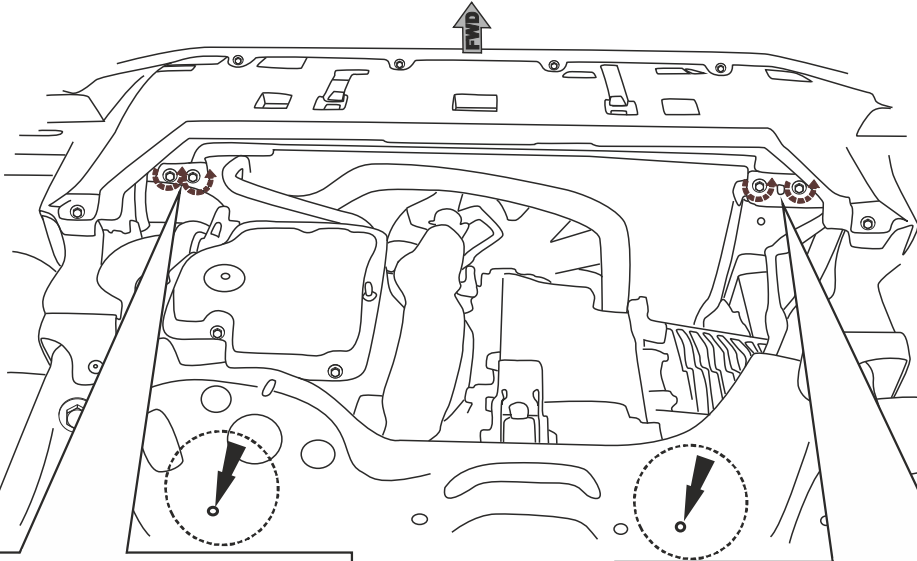
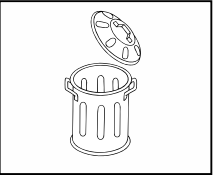

1

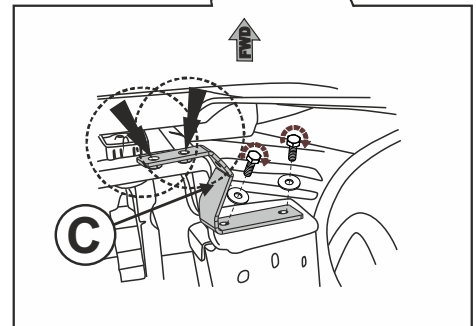
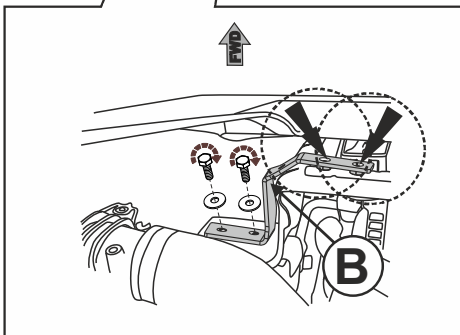
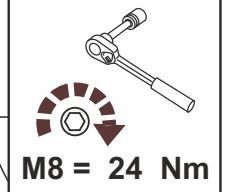
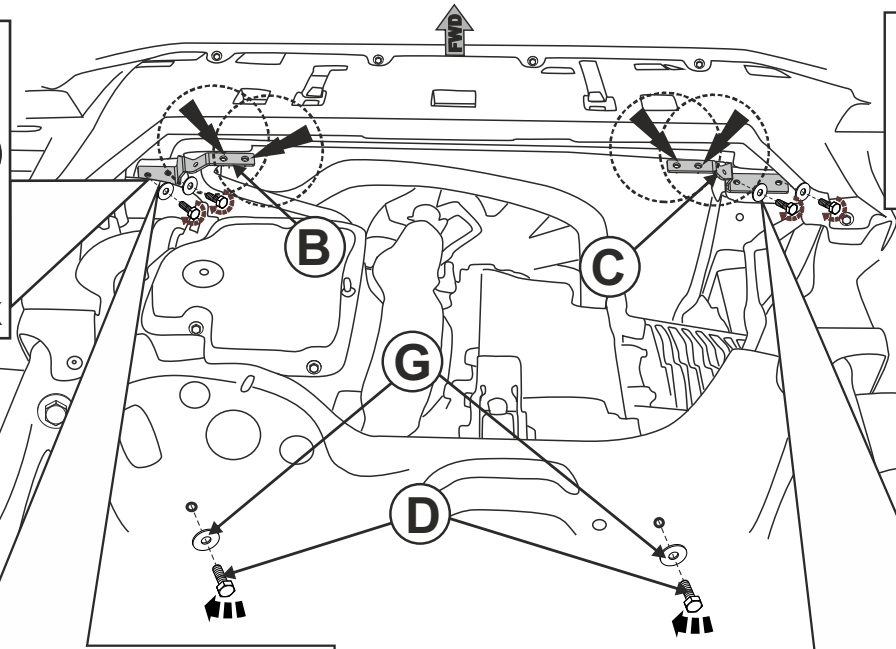
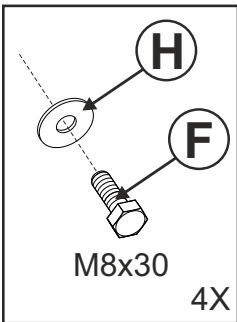

2



05.4415/05.4416
24.4415/24.4416

25/11/19

4/6

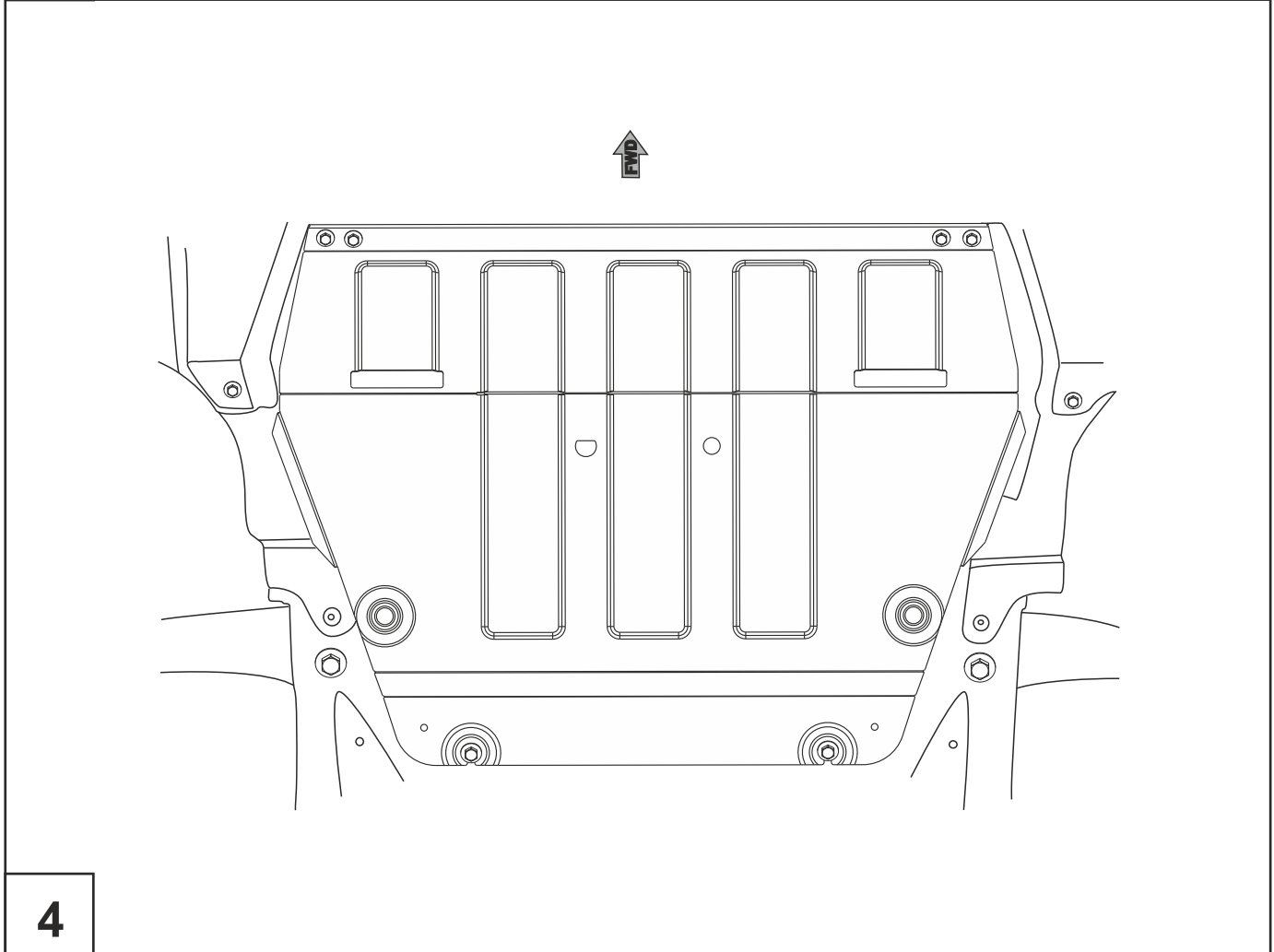
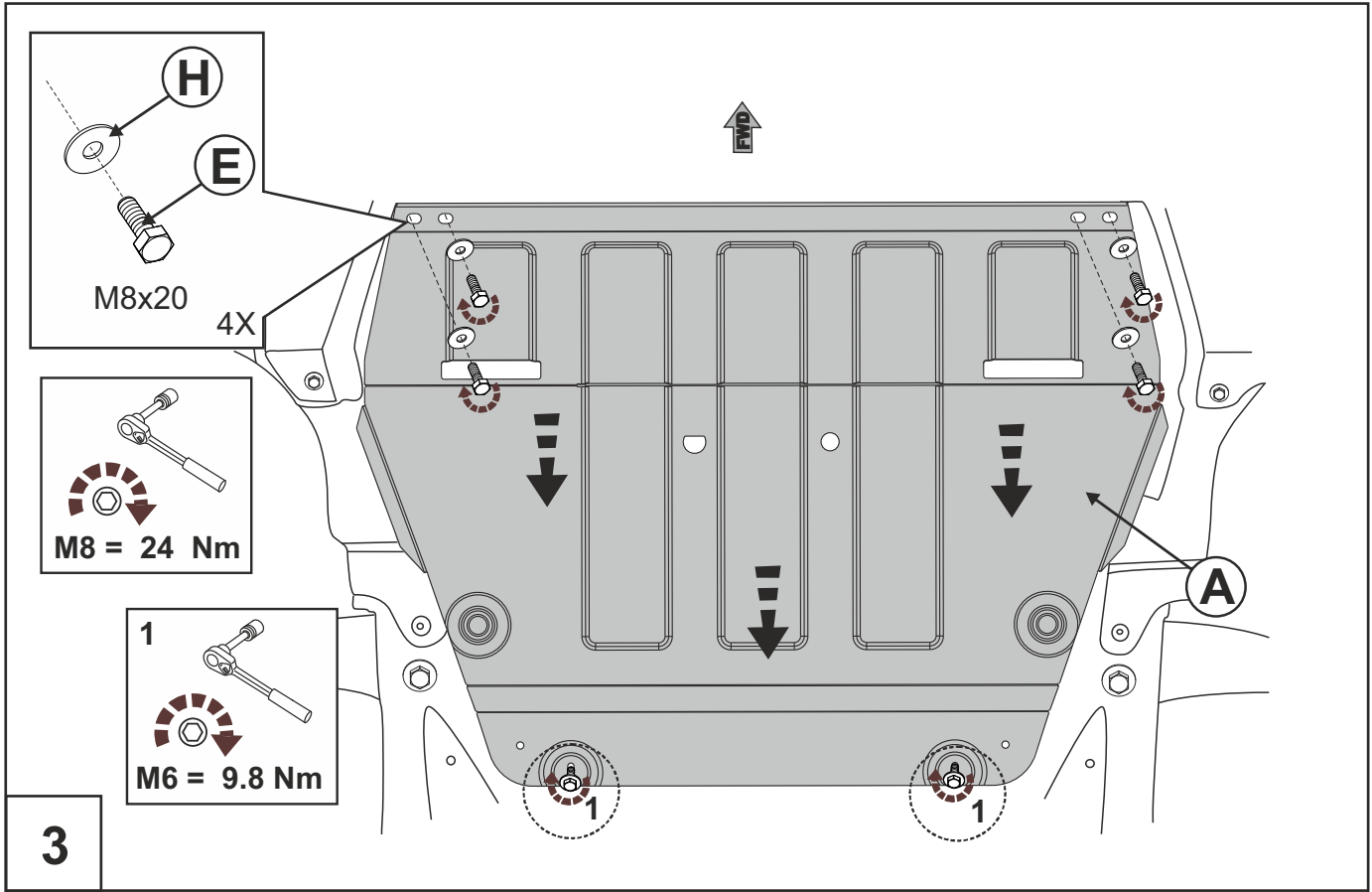

Engine bay and transmission elements skid plate has been designed and manufactured by LLC Metalloproduksia. Product conforms to TOR 4591-001-25888788-2006 requirements. Product design is protected by model copyright certificates №89059, 15980, 15981, 15982, 15983. Patented in Russian Federation.

INSTALLATION:

Engine bay and transmission elements skid plate has been designed particularly for a certain vehicle. It should be mounted according to the producer's installation instruction by a dedicated dealer or on certified service stations. The skid plate is fixed to regular apertures located on vehicle's body load-bearing elements. In case of correct installation the skid plate should not interfere with any vehicle's units and components.

OPERATING CONDITIONS:

Engine bay and transmission elements skid plate has been designed to operate in conditions specified by vehicle's producer. Cases of crush or driving into obstacles at a speed should be excluded during exploitation. In case of head-on crush it is necessary to assure in absence of damages of vehicle's components and units and availability of roadworthiness on certified service stations.

WARRANTY:

Warranty period - 24 months.

WARRANTY TERMS:

The skid plate should be installed on a vehicle with undamaged body and load-bearing elements (vehicle, which has never been involved in road traffic accident);

There are no mechanical damages of the skid plate resulting from head-on crush. All requirements to skid plate installation should be satisfied;

There are no mechanical damages of powder coating.

Producer does not bear liability for damages caused to the vehicle, health and life of people in case of installation and exploitation terms violation. Producer has a right to introduce changes into the skid plate construction.

ENVIRONMENTAL PROTECTION

Dispose of packaging properly. It is recommended to take it for recycling. Don't forget about environmental protection.



05.4415/05.4416
24.4415/24.4416

25/11/19

6/6